

**Модульная система «Этна»
Шкаф Ш 57x50/75/100**

500/750/1000x2300x554 (ШxВxГ)



Уважаемые покупатели! Идеального качества сборки можно добиться только путем привлечения ПРОФЕССИОНАЛЬНОГО (толкового) сборщика мебели.

Все замечания и пожелания присылайте по адресу mebelesonoma@mail.ru, они будут рассмотрены НЕЗАМЕДЛИТЕЛЬНО.



РУССКИЙ

Важная информация
Внимательно прочитайте.
Необходимо тщательно следовать всем рекомендациям.

Сохраните эту информацию для справок в дальнейшем.

ВНИМАНИЕ!

Опрокидывание мебели может стать причиной получения серьезных травм или даже привести к смерти. Чтобы предотвратить опрокидывание, необходимо обеспечить стационарное крепление мебели к стене с помощью крепежных аксессуаров.

Материалы стен различаются, поэтому крепежные средства не прилагаются. Используйте крепежные средства, подходящие для материала стен в вашем доме. Для выбора подходящих крепежных средств обратитесь в специализированный магазин.



ENGLISH

Important information
Read carefully
Follow each step of the instruction carefully

Keep this information for further reference

WARNING!

Serious or fatal crushing injuries can occur from furniture tip-over. To prevent this furniture from tipping over it must be permanently fixed to the wall with the wall attachment devices.

Fastening devices for the wall are not included since different wall materials require different types of fastening devices. Use fastening devices suitable for the walls in your home. For advice on suitable fastening devices, contact your local specialized dealer.

Ш 57x100

| 1 2 3 | L=mm | | | | |
|-------------|------|-----|----|---|---|
| | 1 | 2 | 3 | | |
| 1 | 2300 | 554 | 16 | 1 | 1 |
| 2 | 2300 | 554 | 16 | 1 | 1 |
| 3 | 968 | 554 | 16 | 1 | 2 |
| 4 | 968 | 554 | 16 | 1 | 2 |
| 5 | 968 | 60 | 16 | 1 | 2 |
| 6 | 996 | 558 | 3 | 3 | 2 |
| 7 | 996 | 558 | 3 | 1 | 2 |
| 8 | | | | 3 | 2 |
| 9 | | | | 2 | 2 |

Ш 57x75

| 1 2 3 | L=mm | | | | |
|-------------|------|-----|----|---|---|
| | 1 | 2 | 3 | | |
| 1 | 2300 | 554 | 16 | 1 | 1 |
| 2 | 2300 | 554 | 16 | 1 | 1 |
| 3 | 718 | 554 | 16 | 1 | 2 |
| 4 | 718 | 554 | 16 | 1 | 2 |
| 5 | 718 | 60 | 16 | 1 | 2 |
| 6 | 746 | 558 | 3 | 3 | 2 |
| 7 | 746 | 558 | 3 | 1 | 2 |
| 8 | | | | 3 | 2 |
| 9 | | | | 2 | 2 |

Ш 57x50

| 1 2 3 | L=mm | | | | |
|-------------|------|-----|----|---|---|
| | 1 | 2 | 3 | | |
| 1 | 2300 | 554 | 16 | 1 | 1 |
| 2 | 2300 | 554 | 16 | 1 | 1 |
| 3 | 468 | 554 | 16 | 1 | 2 |
| 4 | 468 | 554 | 16 | 1 | 2 |
| 5 | 468 | 60 | 16 | 1 | 2 |
| 6 | 496 | 558 | 3 | 3 | 2 |
| 7 | 496 | 558 | 3 | 1 | 2 |
| 8 | | | | 3 | 2 |
| 9 | | | | 2 | 2 |

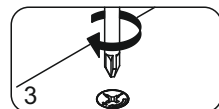
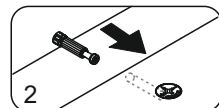
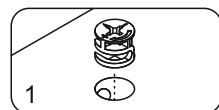
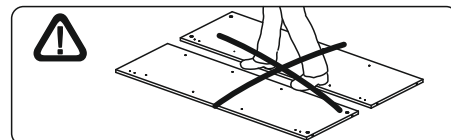
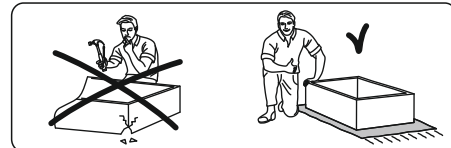
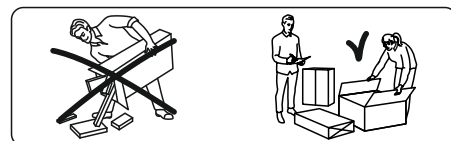
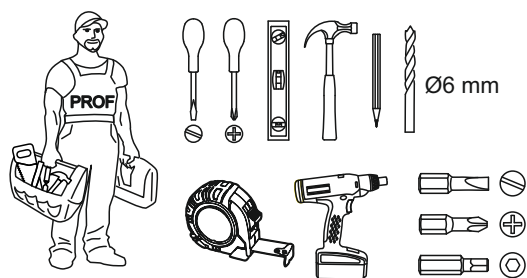

| 6,3x13mm | | | | |
|----------|----|-----|----|----|
| x1 | x2 | x8 | x8 | x4 |
| x6 | x9 | x4 | x3 | x9 |
| x2 | | x70 | x4 | |

1

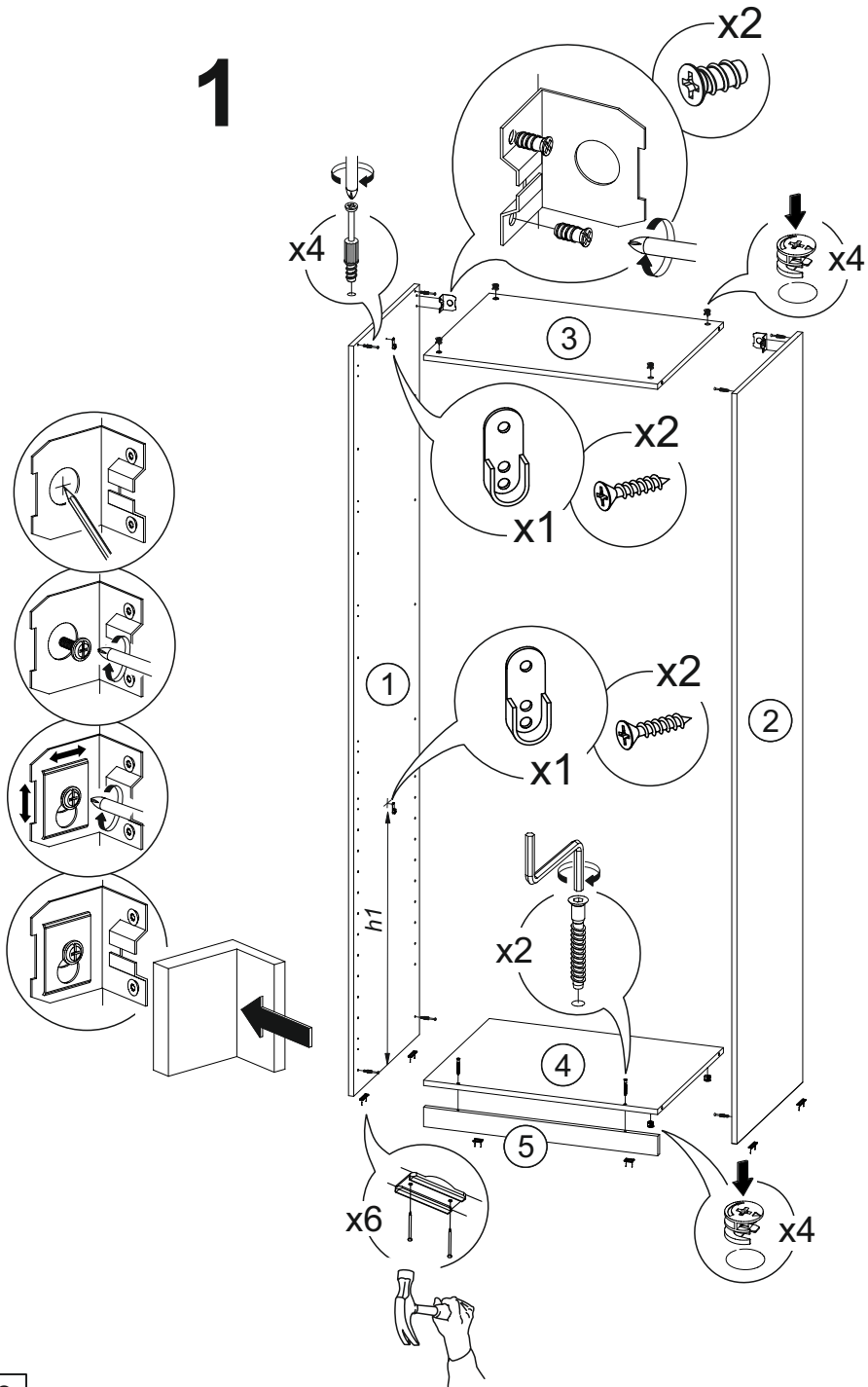

2

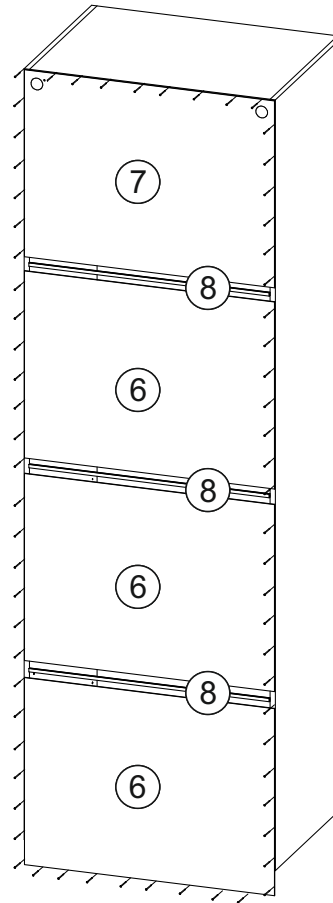

3

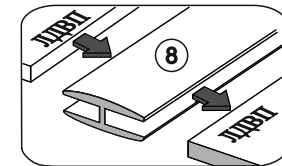
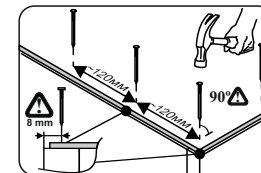
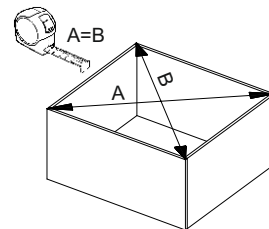
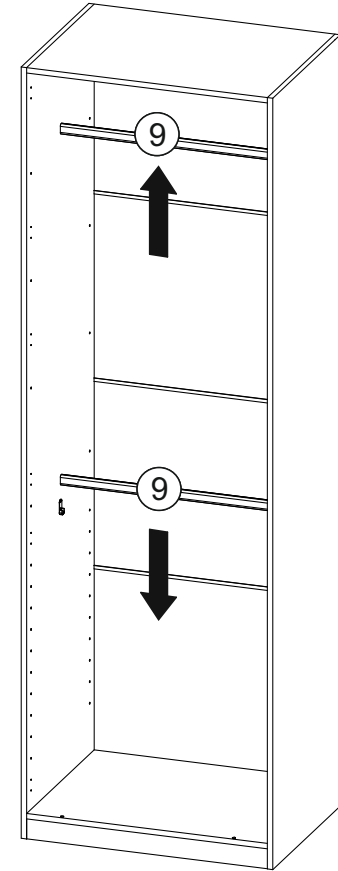

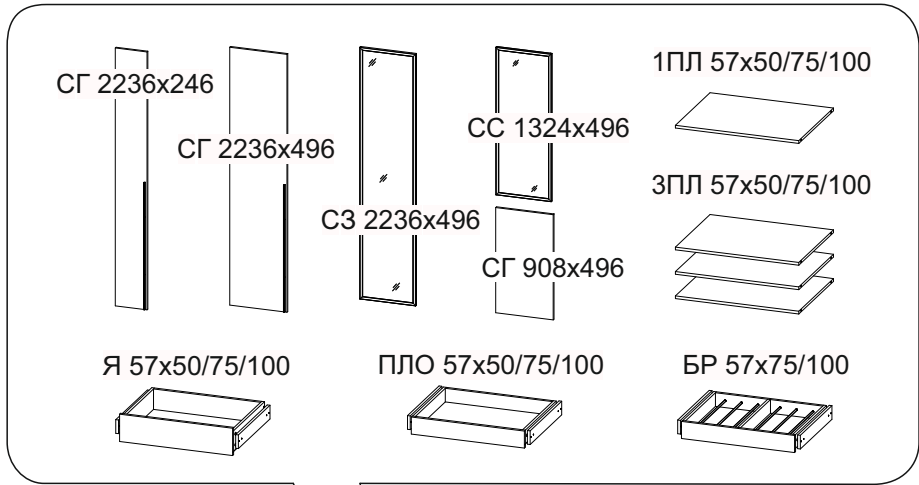







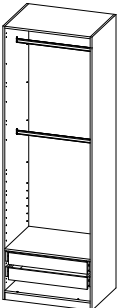
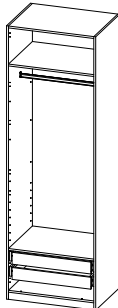
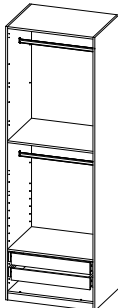
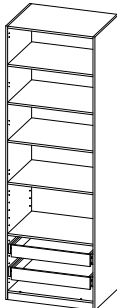
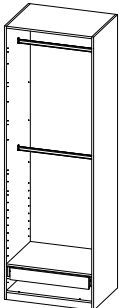
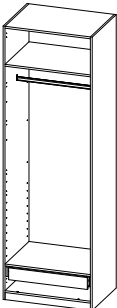
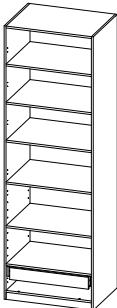

| | | | | |
|----------|----------------|----------|----------------|---|
| A | | B | | |
| | Ш 57x75 | 1 | Ш 57x75 | 1 |
| | CG 2236x496 | 1 | C3 2236x496 | 1 |
| | CG 2236x246 | 1 | CG 2236x246 | 1 |
| | | | 1ПЛ 57x100 | 1 |

| | | | | | | | | | | |
|----------|----------------|----------|----------------|----------|----------------|----------|----------------|----------|----------------|---|
| A | | B | | C | | D | | E | | |
| | Ш 57x50 | 1 | Ш 57x50 | 1 | Ш 57x50 | 1 | Ш 57x50 | 1 | Ш 57x50 | 1 |
| | CG 2236x496 | 1 | C3 2236x496 | 1 | CC 1324x496 | 1 | CG 2236x246 | 2 | CG 908x496 | 1 |
| | | | | | CG 908x496 | 1 | | | 1ПЛ 57x50 | 1 |
| | | | | | 1ПЛ 57x50 | 1 | | | | |

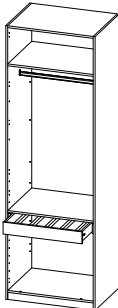
| | | | | | | | | | | |
|----------|-----------------|----------|-----------------|----------|-----------------|----------|-----------------|----------|-----------------|---|
| A | | B | | C | | D | | E | | |
| | Ш 57x100 | 1 | Ш 57x100 | 1 | Ш 57x100 | 1 | Ш 57x100 | 1 | Ш 57x100 | 1 |
| | CG 2236x496 | 2 | C3 2236x496 | 2 | CG 2236x496 | 1 | CC 1324x496 | 2 | CG 908x496 | 2 |
| | | | 1ПЛ 57x100 | 1 | C3 2236x496 | 1 | CG 908x496 | 2 | 1ПЛ 57x100 | 1 |
| | | | | | 1ПЛ 57x100 | 1 | 1ПЛ 57x100 | 1 | | |

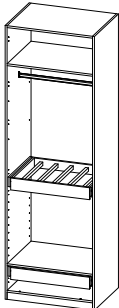
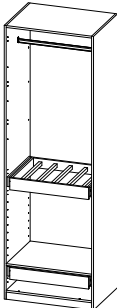
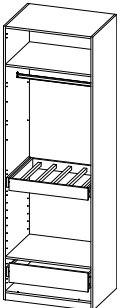
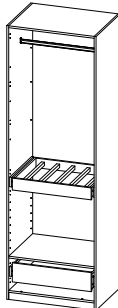
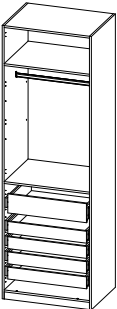
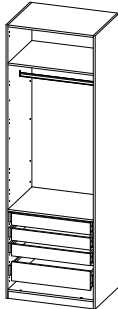
| | | | | | | | | | | | | | | | |
|------------------|---|------------------|---|------------------|---|------------------|---|------------------|---|------------------|---|------------------|---|------------------|---|
| 1 | | 2 | | 3 | | 4 | | 5 | | 6 | | 7 | | 8 | |
| Ш 57x50/75/100 | 1 | Ш 57x50/75/100 | 1 | Ш 57x50/75/100 | 1 | Ш 57x50/75/100 | 1 | Ш 57x50/75/100 | 1 | Ш 57x50/75/100 | 1 | Ш 57x50/75/100 | 1 | Ш 57x50/75/100 | 1 |
| | | 1Пл 57x50/75/100 | 1 | 1Пл 57x50/75/100 | 1 | 1Пл 57x50/75/100 | 2 | 1Пл 57x50/75/100 | 2 | 1Пл 57x50/75/100 | 2 | 3Пл 57x50/75/100 | 1 | 1Пл 57x50/75/100 | 1 |
| | | | | | | | | | | | | | | 3Пл 57x50/75/100 | 1 |
| 9 | | 10 | | 11 | | 12 | | 13 | | 14 | | 15 | | 16 | |
| Ш 57x50/75/100 | 1 | Ш 57x50/75/100 | 1 | Ш 57x50/75/100 | 1 | Ш 57x50/75/100 | 1 | Ш 57x50/75/100 | 1 | Ш 57x50/75/100 | 1 | Ш 57x50/75/100 | 1 | Ш 57x50/75/100 | 1 |
| 1Пл 57x50/75/100 | 1 | 3Пл 57x50/75/100 | 2 | 1Пл 57x50/75/100 | 1 | 1Пл 57x50/75/100 | 2 | 1Пл 57x50/75/100 | 1 | 1Пл 57x50/75/100 | 1 | 1Пл 57x50/75/100 | 2 | 1Пл 57x50/75/100 | 2 |
| 3Пл 57x50/75/100 | 1 | | | Я 57x50/75/100 | 4 | Я 57x50/75/100 | 4 | 3Пл 57x50/75/100 | 1 | Я 57x50/75/100 | 3 | Я 57x50/75/100 | 3 | 3Пл 57x50/75/100 | 1 |
| | | | | | | | | Я 57x50/75/100 | 4 | | | | | Я 57x50/75/100 | 3 |
| 17 | | 18 | | 19 | | 20 | | 21 | | 22 | | 23 | | 24 | |
| Ш 57x50/75/100 | 1 | Ш 57x50/75/100 | 1 | Ш 57x50/75/100 | 1 | Ш 57x50/75/100 | 1 | Ш 57x50/75/100 | 1 | Ш 57x50/75/100 | 1 | Ш 57x50/75/100 | 1 | Ш 57x50/75/100 | 1 |
| 1Пл 57x50/75/100 | 1 | 1Пл 57x50/75/100 | 1 | 1Пл 57x50/75/100 | 2 | 3Пл 57x50/75/100 | 1 | 3Пл 57x50/75/100 | 1 | 1Пл 57x50/75/100 | 2 | 1Пл 57x50/75/100 | 1 | 1Пл 57x50/75/100 | 2 |
| 3Пл 57x50/75/100 | 1 | Я 57x50/75/100 | 2 | Я 57x50/75/100 | 2 | Я 57x50/75/100 | 2 | Я 57x50/75/100 | 2 | 3Пл 57x50/75/100 | 1 | 3Пл 57x50/75/100 | 1 | 3Пл 57x50/75/100 | 1 |
| Я 57x50/75/100 | 3 | | | | | | | | | Я 57x50/75/100 | 2 | Я 57x50/75/100 | 2 | Я 57x50/75/100 | 2 |

| | | | | | | | | | | | | | | | |
|------------------|---|------------------|---|------------------|---|------------------|---|------------------|---|------------------|---|------------------|---|------------------|---|
| 25 | | 26 | | 27 | | 28 | | 29 | | 30 | | 31 | | 32 | |
| Ш 57x50/75/100 | 1 | Ш 57x50/75/100 | 1 | Ш 57x50/75/100 | 1 | Ш 57x50/75/100 | 1 | Ш 57x50/75/100 | 1 | Ш 57x50/75/100 | 1 | Ш 57x50/75/100 | 1 | Ш 57x50/75/100 | 1 |
| 1ПЛ 57x50/75/100 | 1 | 1ПЛ 57x50/75/100 | 2 | 3ПЛ 57x50/75/100 | 1 | 1ПЛ 57x50/75/100 | 1 | 1ПЛ 57x50/75/100 | 2 | 1ПЛ 57x50/75/100 | 2 | 1ПЛ 57x50/75/100 | 1 | 3ПЛ 57x50/75/100 | 1 |
| Я 57x50/75/100 | 2 | Я 57x50/75/100 | 2 | Я 57x50/75/100 | 2 | Я 57x50/75/100 | 1 | Я 57x50/75/100 | 1 | Я 57x50/75/100 | 1 | 3ПЛ 57x50/75/100 | 1 | Я 57x50/75/100 | 1 |
| | | | | | | | | | | | | Я 57x50/75/100 | 1 | | |
| 33 | | 34 | | 35 | | 36 | | 37 | | 38 | | 39 | | 40 | |
| Ш 57x50/75/100 | 1 | Ш 57x50/75/100 | 1 | Ш 57x50/75/100 | 1 | Ш 57x50/75/100 | 1 | Ш 57x50/75/100 | 1 | Ш 57x50/75/100 | 1 | Ш 57x50/75/100 | 1 | Ш 57x50/75/100 | 1 |
| 3ПЛ 57x50/75/100 | 2 | 1ПЛ 57x50/75/100 | 2 | 1ПЛ 57x50/75/100 | 1 | 1ПЛ 57x50/75/100 | 1 | 1ПЛ 57x50/75/100 | 2 | 1ПЛ 57x50/75/100 | 1 | 1ПЛ 57x50/75/100 | 2 | 1ПЛ 57x50/75/100 | 2 |
| Я 57x50/75/100 | 1 | 3ПЛ 57x50/75/100 | 1 | ПЛО 57x50/75/100 | 5 | ПЛО 57x50/75/100 | 5 | ПЛО 57x50/75/100 | 5 | 3ПЛ 57x50/75/100 | 1 | ПЛО 57x50/75/100 | 4 | 3ПЛ 57x50/75/100 | 1 |
| | | Я 57x50/75/100 | 1 | | | | | | | ПЛО 57x50/75/100 | 5 | | | ПЛО 57x50/75/100 | 4 |
| 41 | | 42 | | 43 | | 44 | | 45 | | 46 | | 47 | | 48 | |
| Ш 57x50/75/100 | 1 | Ш 57x50/75/100 | 1 | Ш 57x50/75/100 | 1 | Ш 57x50/75/100 | 1 | Ш 57x50/75/100 | 1 | Ш 57x50/75/100 | 1 | Ш 57x50/75/100 | 1 | Ш 57x50/75/100 | 1 |
| 1ПЛ 57x50/75/100 | 1 | 1ПЛ 57x50/75/100 | 2 | 1ПЛ 57x50/75/100 | 1 | 1ПЛ 57x50/75/100 | 1 | 1ПЛ 57x50/75/100 | 2 | 1ПЛ 57x50/75/100 | 1 | 1ПЛ 57x50/75/100 | 2 | 1ПЛ 57x50/75/100 | 2 |
| ПЛО 57x50/75/100 | 4 | ПЛО 57x50/75/100 | 4 | 3ПЛ 57x50/75/100 | 1 | ПЛО 57x50/75/100 | 3 | ПЛО 57x50/75/100 | 3 | ПЛО 57x50/75/100 | 3 | ПЛО 57x50/75/100 | 3 | 3ПЛ 57x50/75/100 | 1 |
| | | | | ПЛО 57x50/75/100 | 4 | | | | | | | | | ПЛО 57x50/75/100 | 3 |

| | | | | | | | | | | | | | | | | |
|------------------|---|------------------|---|------------------|---|------------------|--|------------------|---|------------------|---|------------------|---|---------------|---|--|
| 49 |  | 50 |  | 51 |  | 52 |  | 53 |  | 54 |  | 55 |  | | | |
| Ш 57x50/75/100 | 1 | Ш 57x50/75/100 | 1 | Ш 57x50/75/100 | 1 | Ш 57x50/75/100 | 1 | Ш 57x50/75/100 | 1 | Ш 57x50/75/100 | 1 | Ш 57x50/75/100 | 1 | | | |
| 1Пл 57x50/75/100 | 1 | 1Пл 57x50/75/100 | 2 | 1Пл 57x50/75/100 | 2 | 1Пл 57x50/75/100 | 2 | 1Пл 57x50/75/100 | 1 | 1Пл 57x50/75/100 | 2 | 3Пл 57x50/75/100 | 2 | | | |
| ПЛО 57x50/75/100 | 2 | ПЛО 57x50/75/100 | 2 | ПЛО 57x50/75/100 | 2 | 3Пл 57x50/75/100 | 1 | ПЛО 57x50/75/100 | 1 | ПЛО 57x50/75/100 | 1 | ПЛО 57x50/75/100 | 1 | | | |
| | | | | | | ПЛО 57x50/75/100 | 2 | | | | | | | | | |
| 56 |  | 57 |  | 58 |  | 59 |  | 60 |  | 61 |  | 62 |  | 63 |  | |
| Ш 57x75/100 | 1 | Ш 57x75/100 | 1 | Ш 57x75/100 | 1 | Ш 57x75/100 | 1 | Ш 57x75/100 | 1 | Ш 57x75/100 | 1 | Ш 57x75/100 | 1 | Ш 57x75/100 | 1 | |
| 1Пл 57x75/100 | 1 | 1Пл 57x75/100 | 2 | 1Пл 57x75/100 | 1 | 1Пл 57x75/100 | 4 | 1Пл 57x75/100 | 2 | 1Пл 57x75/100 | 1 | 1Пл 57x75/100 | 2 | 1Пл 57x75/100 | 1 | |
| БР 57x75/100 | 1 | БР 57x75/100 | 1 | 3Пл 57x75/100 | 1 | БР 57x75/100 | 1 | БР 57x75/100 | 1 | БР 57x75/100 | 1 | БР 57x75/100 | 1 | БР 57x75/100 | 1 | |
| | | | | БР 57x75/100 | 1 | ПЛО 57x75/100 | 1 | ПЛО 57x75/100 | 1 | ПЛО 57x75/100 | 1 | Я 57x75/100 | 1 | Я 57x75/100 | 1 | |
| 64 |  | 65 |  | 66 |  | 67 |  | 68 |  | 69 |  | | | | | |
| Ш 57x50/75/100 | 1 | Ш 57x50/75/100 | 1 | Ш 57x50/75/100 | 1 | Ш 57x50/75/100 | 1 | Ш 57x50/75/100 | 1 | Ш 57x50/75/100 | 1 | | | | | |
| 1Пл 57x50/75/100 | 2 | 1Пл 57x50/75/100 | 2 | 1Пл 57x50/75/100 | 2 | 1Пл 57x50/75/100 | 2 | 1Пл 57x50/75/100 | 2 | 1Пл 57x50/75/100 | 2 | | | | | |
| Я 57x50/75/100 | 1 | Я 57x50/75/100 | 1 | Я 57x50/75/100 | 3 | Я 57x50/75/100 | 3 | Я 57x50/75/100 | 2 | Я 57x50/75/100 | 2 | | | | | |
| ПЛО 57x50/75/100 | 4 | ПЛО 57x50/75/100 | 3 | ПЛО 57x50/75/100 | 1 | ПЛО 57x50/75/100 | 1 | ПЛО 57x50/75/100 | 2 | ПЛО 57x50/75/100 | 2 | | | | | |